

A Presentation on

BIM Implementation
for Construction
Projects
and Developer

About

Welcome to the world of CSoft Services!

CSoft is a Norwegian company with a unique skillset of engineering design using AEC, Development on CAD Open API and more. CSoft have more than fifteen years of intellectual nourishment in the global arena.

Vision

- ❑ To become a think-tank in intellect power outsourcing, in the arena of Building Information Modelling (BIM) services
- ❑ To supply services to market, leaders in engineering design and drafting. Our target is to transform any dream into reality To become a sample of cost-effectiveness and accountability with providing a very skillful and opportune design solutions to our proud customers One-stop solution for a creative and unique solution to any engineering design and drafting, anywhere at any time .
- ❑ Power to set the yardstick in design and drafting, without any hesitation

What is **BIM**
Building Information Modeling

for Construction Projects
and Developer ?

BIM - Building Information Modeling

Building Information Modeling (BIM) is a digital representation of physical and functional characteristics of a facility.

BIM is the shared knowledge resource of information. It is also the life time quality administration of any project. BIM, not only manages and model graphics, but also all information. This information allows automatic generation of drawings and reports with design analysis, schedule simulation, facilities management, and much more.

BIM - Beneficiary

Architect

Owner

Engineer

Consultant

Contractor

Vendor

Investor

Stakeholder

What are **BIM**
Building Information Modeling Technology
Advantages ?
Advantages?

Faster Conceptualization Design Visualization

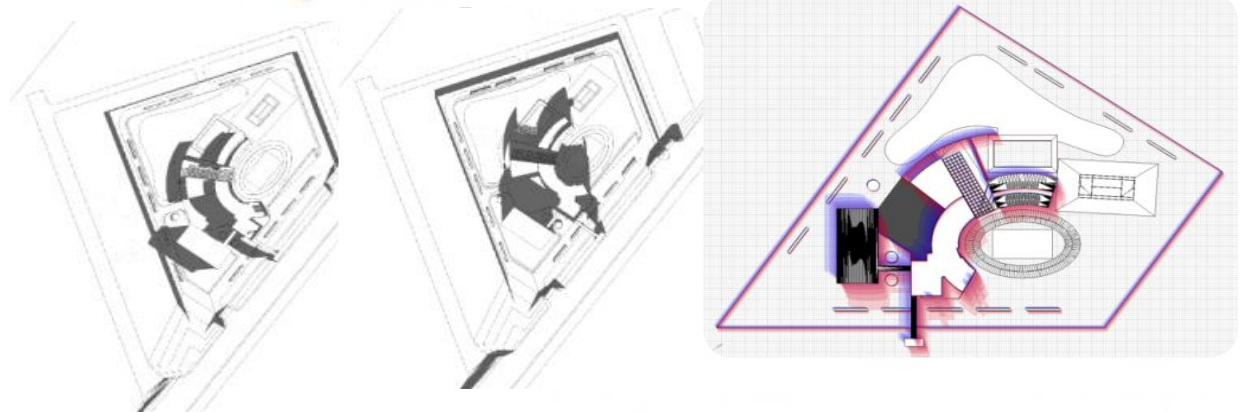
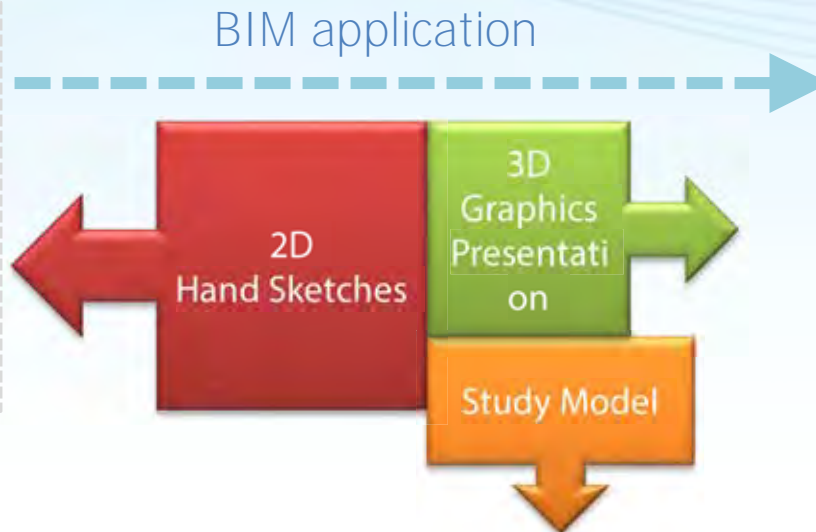
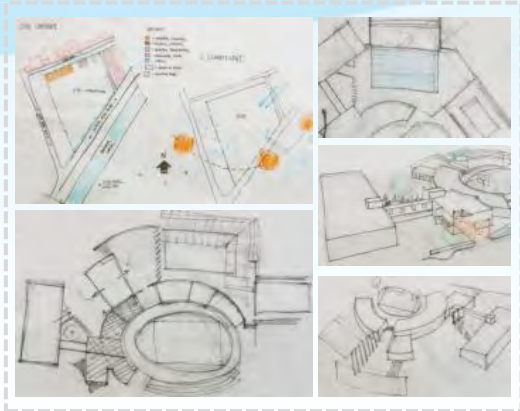

- Direct 3d modeling
- Volumetric study
- Solar study and shadow analysis

Decision making - Feasibility vs. Viability
Option selection



Design
Alternatives

Design
Constructability

Budget
Planning

Material
Selection

Engineering Changes made Easy

BIM - Advantages

Construction Document Generation
Prefabrication



Elevation



BIM Model

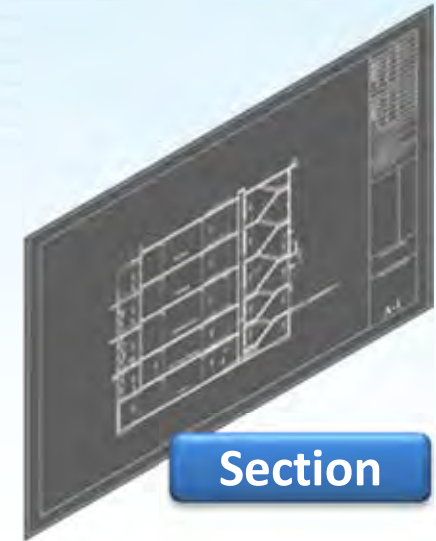

Section



Detail

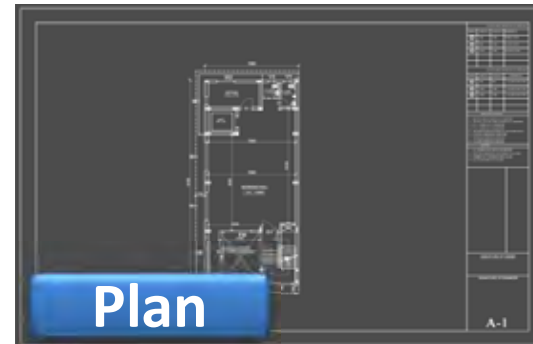

Plan



Schedule

Interlinked interface

Service planning -MEP

- Planning of HVACs in 3D
- Flow analysis - throw & return
- Energy simulation - Heat loss & heat gain
- Clash detection & co-ordination
- Electrical load calculation
- Plumbing design
- Construction Drawings
- Fabrication details to vendor

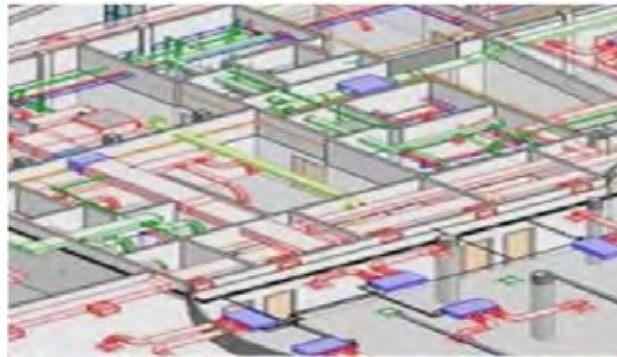

BOQ & Cost Estimation

- Itemized quantity extraction
- Accurate quantity material takeoff
- No additional manipulation
- Specification compliance
- CPWD / others BOQ formats
- Billing

Project Management



- Phasing and monitoring of volume of work
- Inventory and store management
- Taskforce planning & manpower management
- 4D real time simulation
- Bill verification



BIM - Evolution of New Design Process

PD: Pre-design **SD:** Schematic design **DD:** Design development **CD:** Construction Documentation
PR: Procurement **CA:** Construction Administration **OP:** Operation

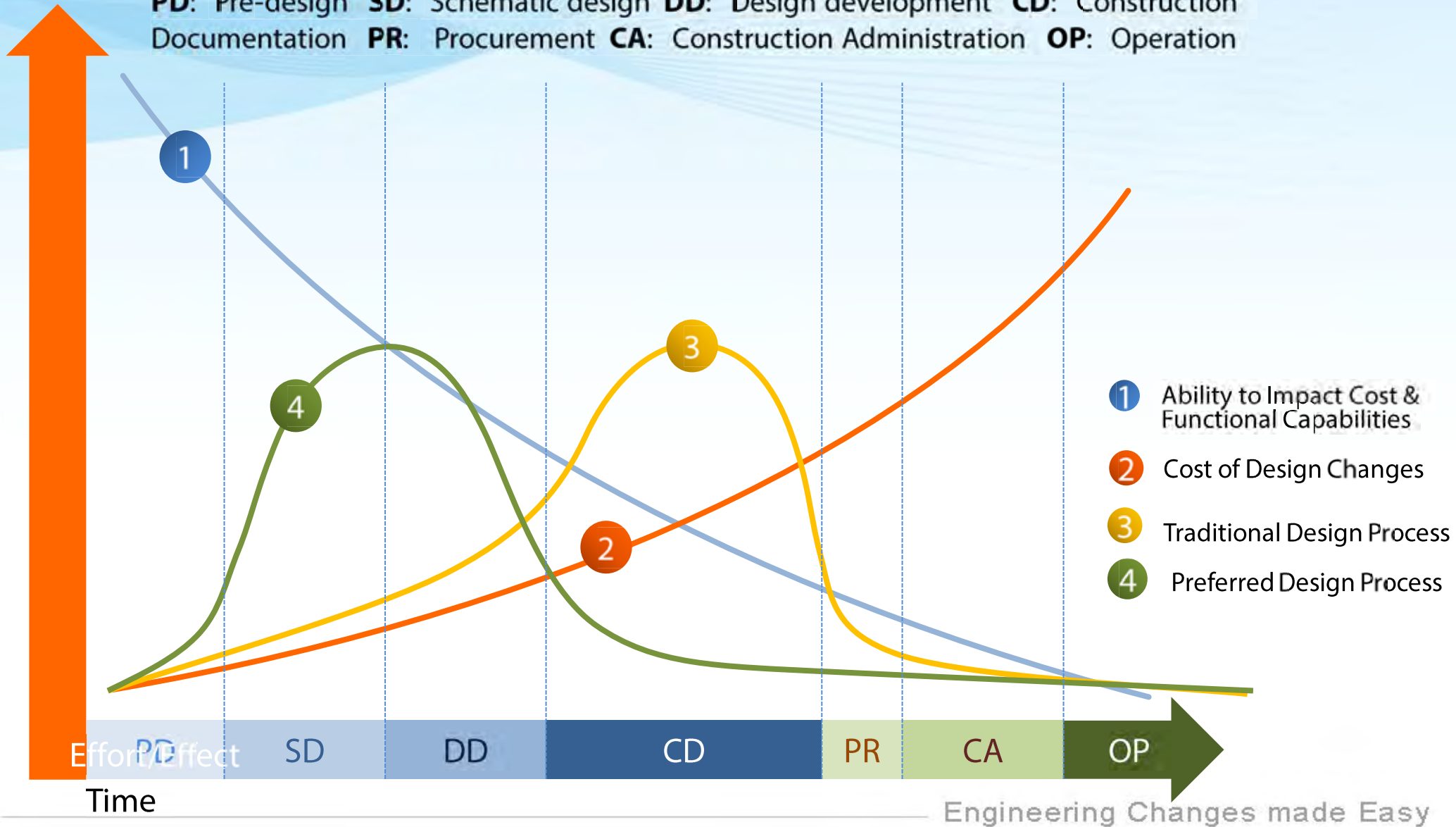

- What are those other benefits of BIM Technology

BIM - Benefits

Accuracy & Reliability

Time Saving Technique

Cost Effective Solution

Easy Information Exchange

3D printing of Mockups

Simulation

Inventory & Asset Management

SCADA & BMS Integration

Building Operation Management

BIM PROJECTS

Residential Building
Service Planning & Modeling
Clash View Modeling
Structural Modeling
Office Space Interiors
Commercial Interior
Residential Interior
Residential Exterior
Building Exterior

Case Studies

Residential Building



Scope of work:
3D Visualization
BOQ & Tender
Documents.
Complete CD

Residential Building



Scope of work:
3D Visualization
Energy Analysis
Structural Detailing
BOQ
Pre-fabrication

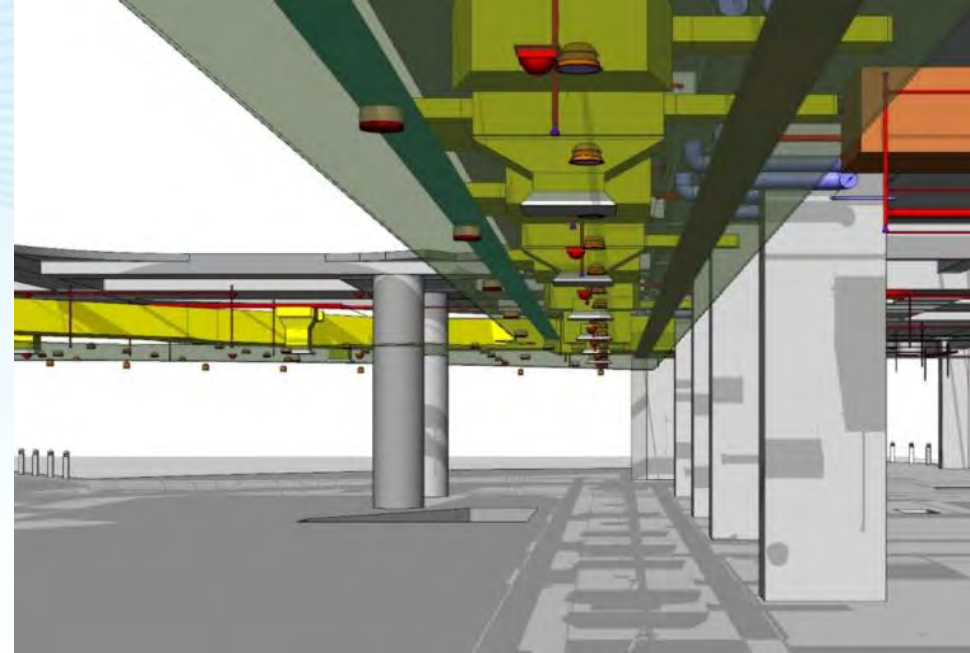
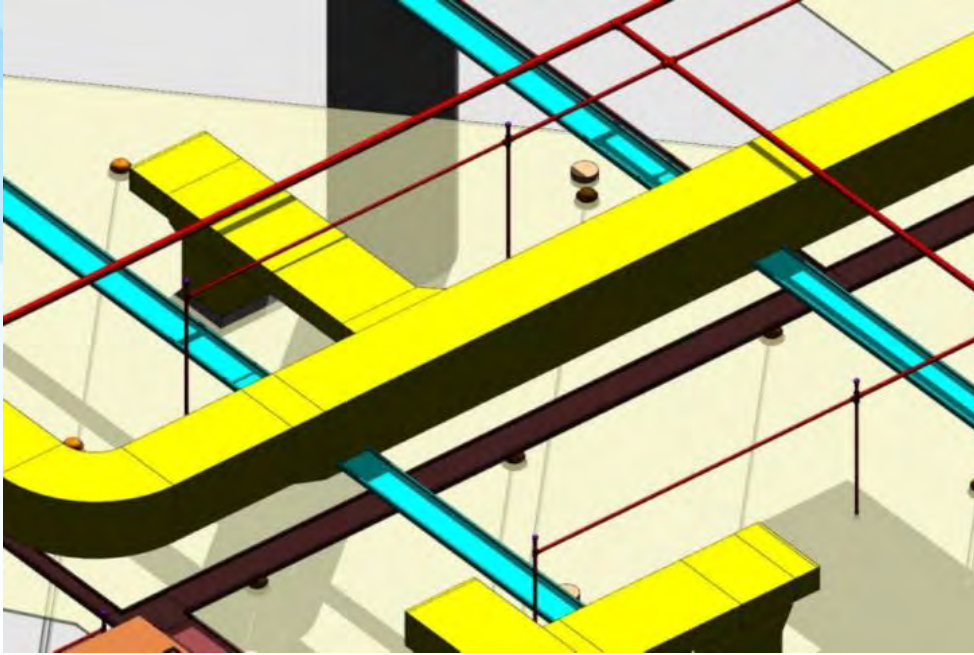

Scope of work:
3D Visualization
Clash Point Checking
& Solutions
Pre-fabrication

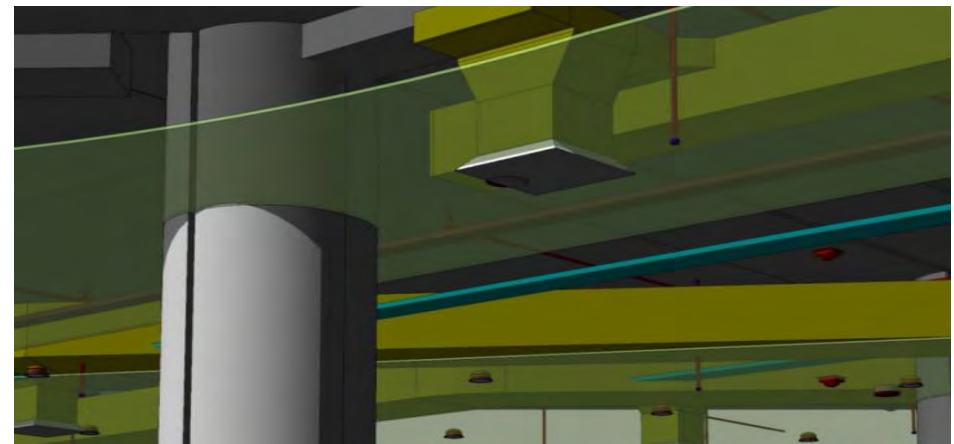

Clash View Modeling

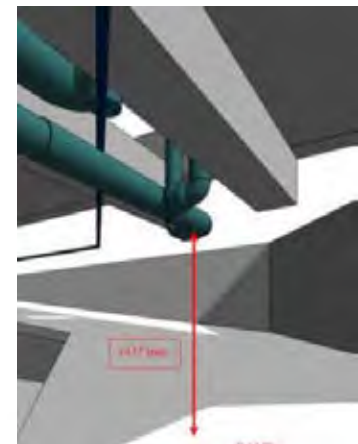
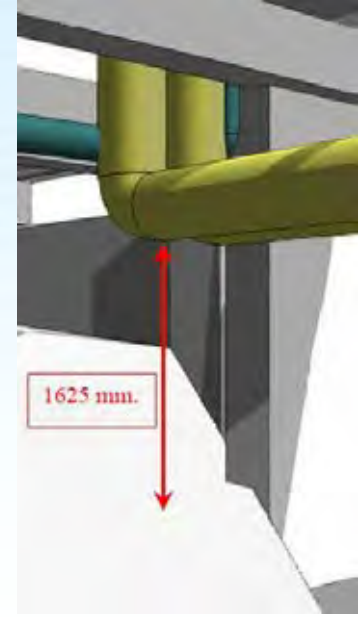
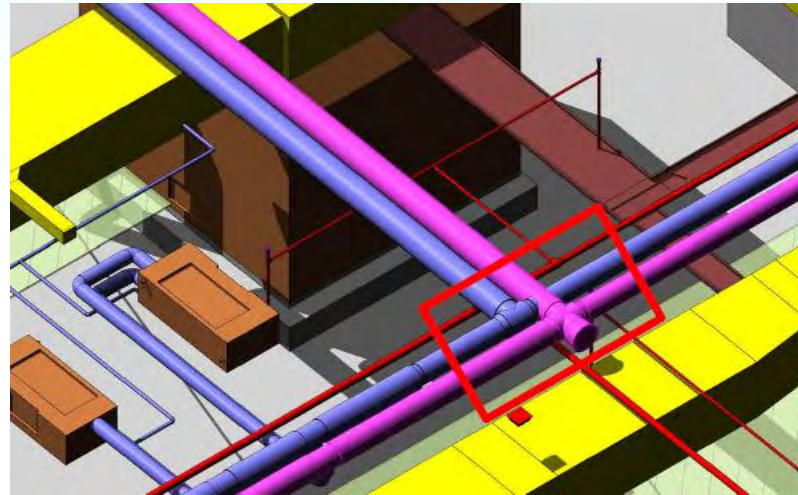
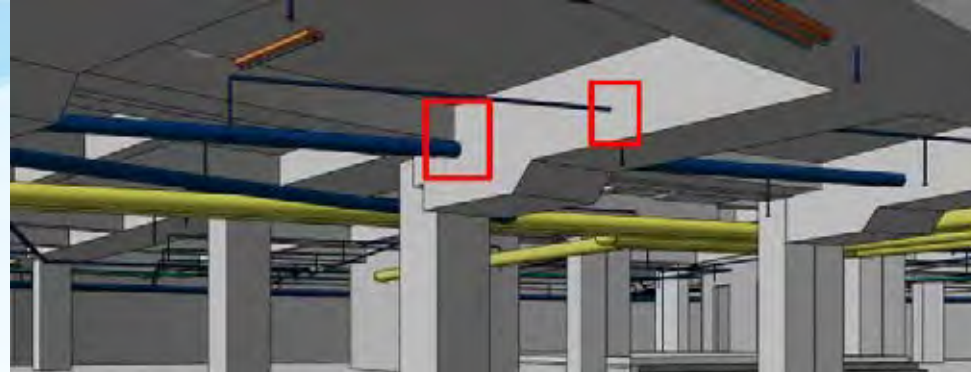

Scope of work:
3D Visualization
Clash Point Checking
& Solutions
Pre-fabrication

Structural BIM Modeling (Steel)

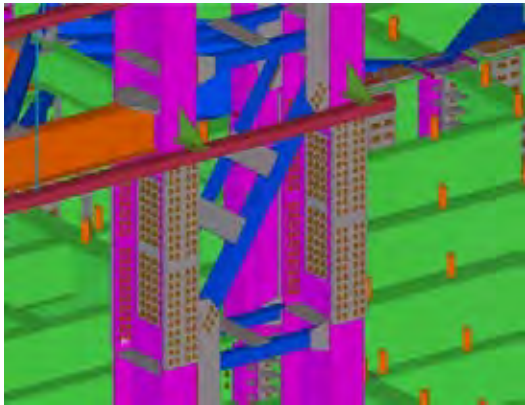
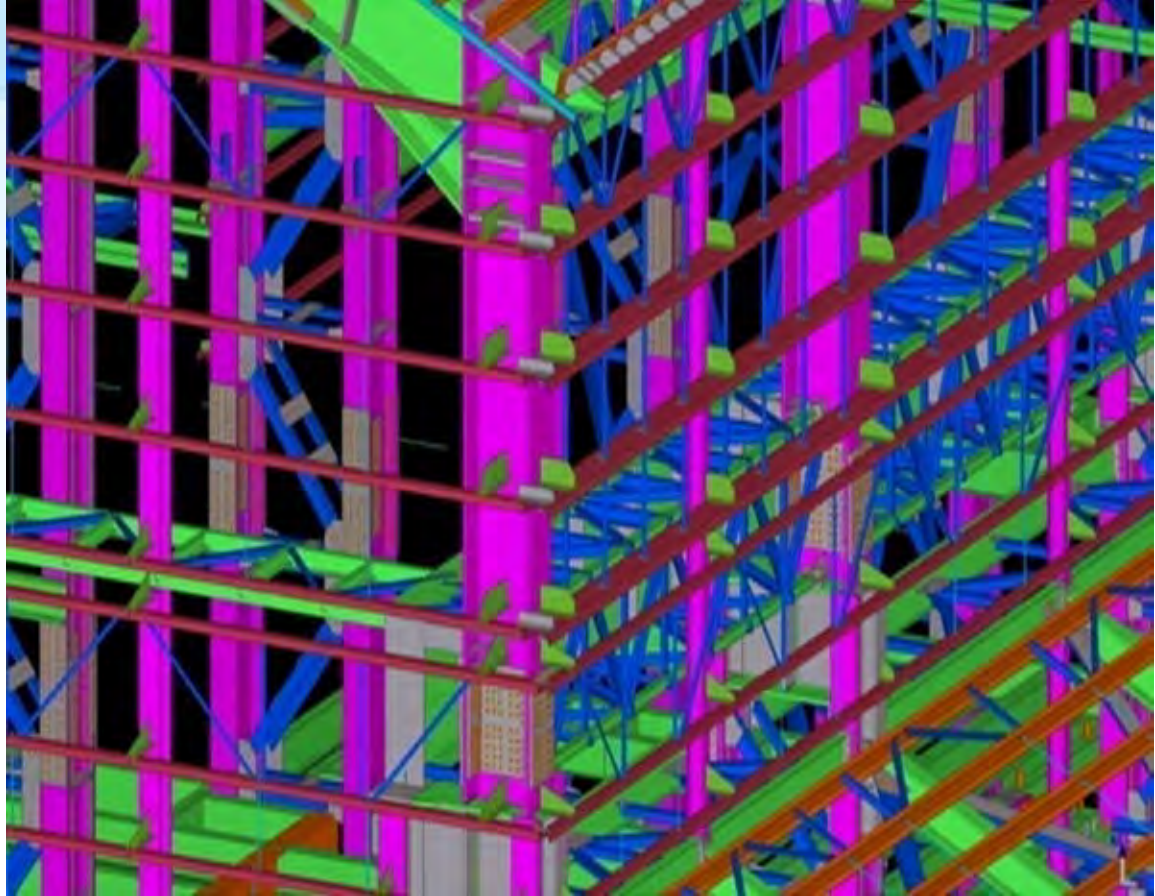
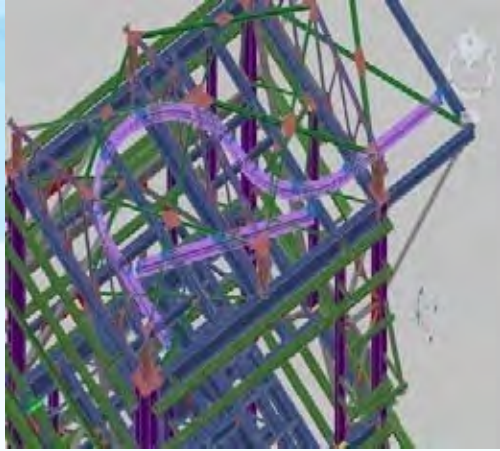

Scope of work:
Steel Structural BIM Model
G.A & Detail Drawings
Shop Drawing

Scope of work:
3D Visualization
& Photorealistic



Commercial Interior (Restaurant)



Scope of work:
3D Visualization

Residential Interior

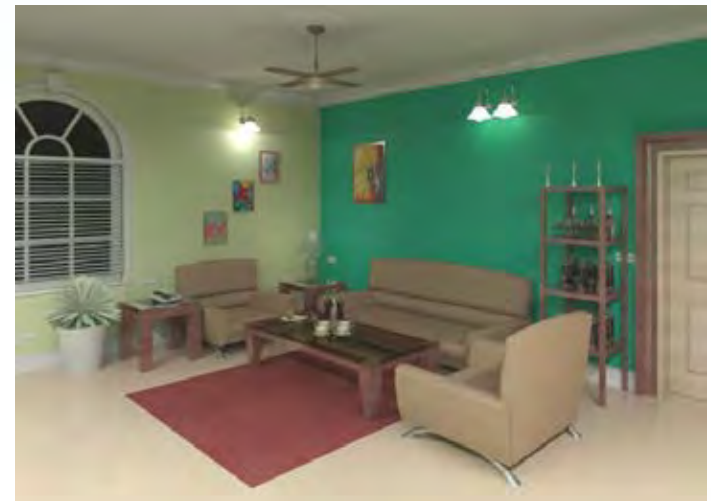

Scope of work:
3D Visualization
Client Choice



Scope of work:
3D Visualization
& Photorealistic



Daylight View



Night View

Scope of work:
3D Visualization
& Photorealistic

Residential Exterior



Scope of work:
3D Visualization
& Photorealistic

CSoft Norway

Frode Rødland, fro@csoft.com
+47 92892800

CSoft India

Arun Talukdar, arun@csoft.com
+91 9748468686



Thank You
From Team

